

**de** Montageanleitung  
**en** Mounting instructions  
**fr** Instructions de montage  
**sv** Monteringsinstruktion  
**nl** Montagehandleiding  
**it** Istruzioni di montaggio  
**fi** Asennusohje  
**es** Instrucciones de montaje  
**da** Monteringsvejledning  
**pl** Instrukcja montażu  
**cz** Montážní návod  
**hu** Szerelési útmutató  
**el** Οδηγίες εγκατάστασης  
**zh** 安裝指導

**Aufbausatz**  
**Mounting kit**  
**Kit de montage**  
**Monteringsssats**  
**Opbouwset**  
**Accoppiamento**  
**Asennussarja**  
**Equipo de montaje**  
**Montasjesats**  
**Zestaw montażowy**  
**Montážní sada**  
**Összeépítő készlet**  
**Μοχλισμός εγκατάστασης**  
**安裝套件**



**ASK32**

SQK33..., SQL33...  
 SQL83...  
 VBG31..., VBI31...  
 VBF21.40, VBF21.50  
 VCI31...

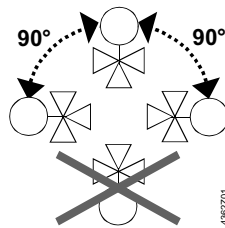
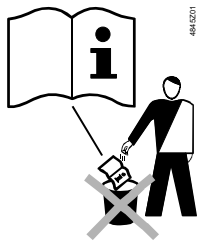

**1** SQK33...  
 SQL33...  
 SQL83...

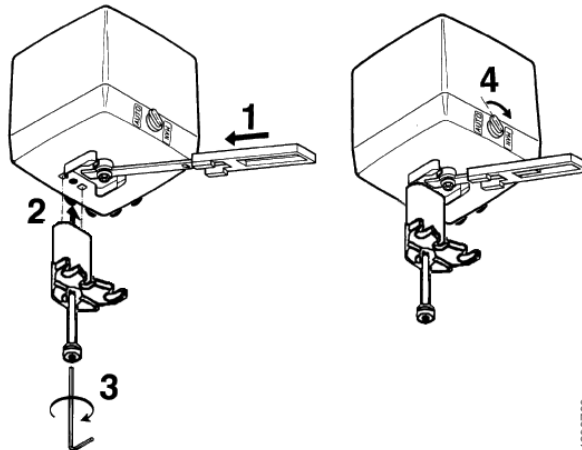

**2a** VB...  
 Series 01

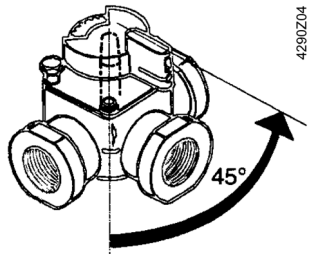

VB...  
 Series 02

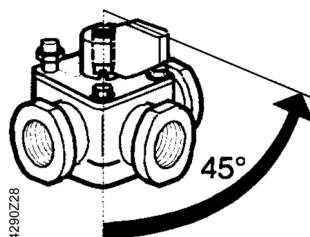

**2b** VC...  
 Series 01

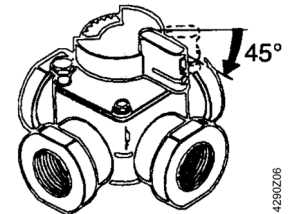

VC...  
 Series 02

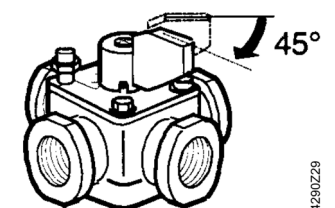

# 3a

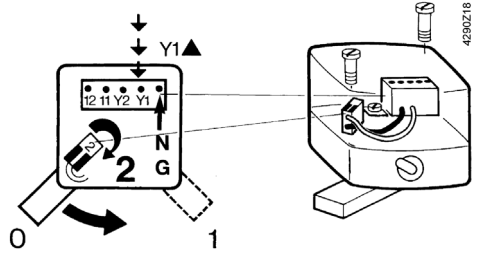
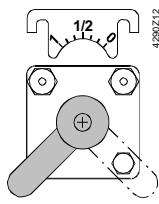
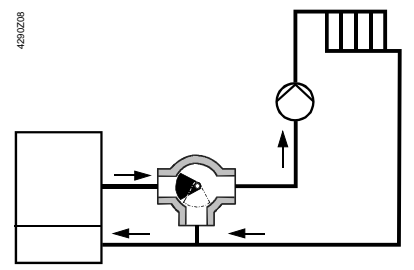
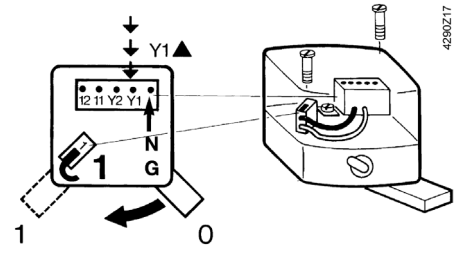
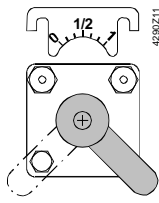
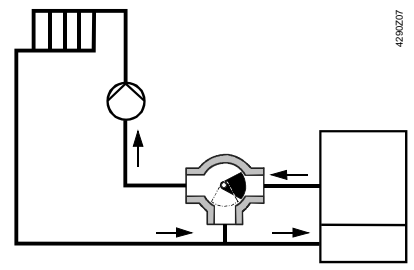

# 3b

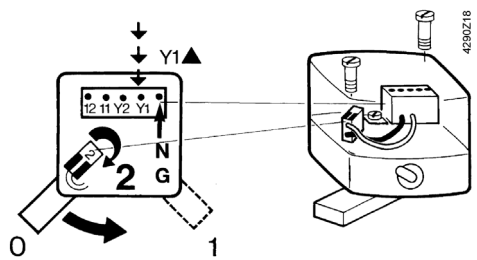
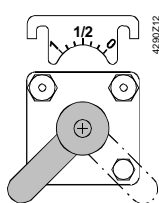
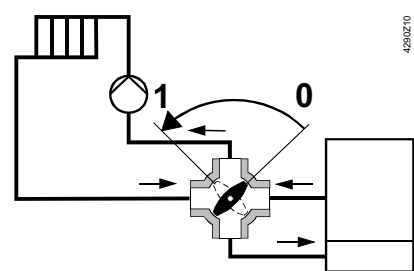
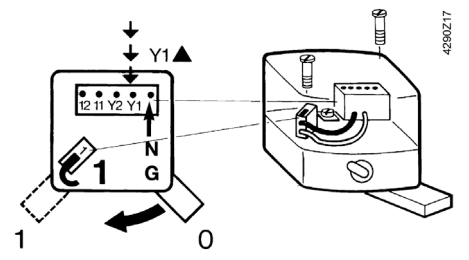
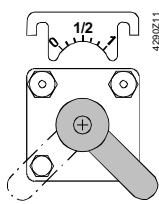
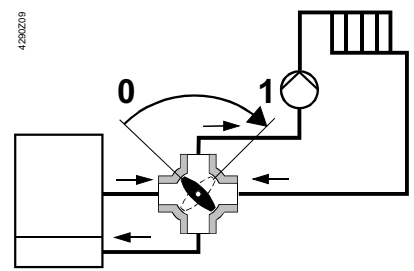

# 4

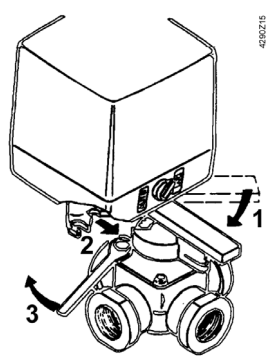

# 5

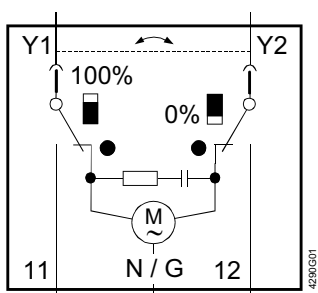
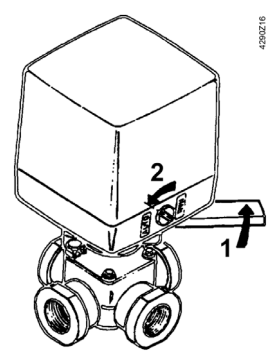

N: SQK33...  
SQL33...  
G: SQL83...

	11, 12	Y1, Y2	N	G
de	Stellsignal Sequenz	Stellsignal	Neutralleiter	Systempotential
en	Control signal sequence	Control signal	Neutral	System potential
fr	Séquence du signal de positionnement	Signal de commande	Neutre	Potentiel du système
sv	Styrsignal sekvens	Styrsignal	Nolledare	Systempotential
nl	Regelaar volgorde-signaal	Besturings-signaal	Nul	Systeem-potentiaal
it	Controllo segnale di sequenza	Segnale di comando	Neutro	Fase del sistema
fi	Säätöviestien sarja	Ohjausviesti	Nollajohdin	Järjestelmäpotentiaali
es	Señal fin de carrera	Señal de control	Neutro	Fase para equipos
da	Styresignal sekvens	Styre-signal	Nulleder	System-fase
pl	Sygnal sterujący sekwencji	Sygnal sterujący	Przewód zerowy	Potencjal systemowy
cz	Sekvence řídicího signálu	Řídicí signál	Nulový vodič	Systémový potenciál
hu	Vezérlőjel szekvencia	Vezérlőjel	Nulla (N)	Rendszer fázis
el	Τεματική επαφή	Σήμα ελέγχου	Ουδέτερος	Φάση
zh	控制信号序列	控制信号	电源零线	额定电源